

eMIMO1616

DIGITAL MATRIXES

Digital audio matrix 16x16



USER MANUAL

INDEX

1. IMPORTANT REMARK	3
2. IMPORTANT SAFETY INSTRUCTIONS.....	3
3. IMPORTANT NOTE	5
4. INTRODUCTION.....	5
5. INSTALLATION AND CONNECTION	8
5.1. <i>Location, assembly and ventilation</i>	<i>8</i>
5.2. <i>Connection to the mains supply and switching on</i>	<i>8</i>
5.3. <i>Local audio input connections</i>	<i>9</i>
5.4. <i>Remote audio input connections</i>	<i>11</i>
5.5. <i>PAGER A, PAGER B connections and priority PAGER / DUCKER modules.....</i>	<i>12</i>
5.6. <i>REMOTE INPUTS 1 to 8 connections</i>	<i>13</i>
5.7. <i>REMOTE PORTS, RJ45 interface pinout.....</i>	<i>14</i>
5.8. <i>Audio output connections</i>	<i>14</i>
5.9. <i>ETHERNET and RS-232 ports for programming and control.....</i>	<i>15</i>
5.10. <i>MUTE port.....</i>	<i>16</i>
6. CONFIGURATION AND CONTROL.....	16
6.1. <i>Configuration via embedded web application.....</i>	<i>16</i>
6.2. <i>Front panel control.....</i>	<i>18</i>
7. FUNCTION LIST.....	22
8. FUNCTION DIAGRAM	24
9. BLOCK DIAGRAM	25
10. TECHNICAL CHARACTERISTICS	26

1. IMPORTANT REMARK



WARNING: SHOCK HAZARD - DO NOT OPEN
 AVIS: RISQUE DE CHOC ÉLECTRIQUE - NE PAS OUVRIR



The lightning flash with arrowhead symbol, within an equilateral triangle, is intended to alert the user to the presence of uninsulated “dangerous voltage” within the product’s enclosure that may be of sufficient magnitude to constitute a risk of electric shock to persons.



The exclamation point within an equilateral triangle is intended to alert the user to the presence of important operating and maintenance (servicing) instructions in the literature accompanying the appliance.

WARNING (If applicable): The terminals marked with symbol of “” may be of sufficient magnitude to constitute a risk of electric shock. The external wiring connected to the terminals requires installation by an instructed person or the use of ready-made leads or cords.

WARNING: To prevent fire or shock hazard, do not expose this equipment to rain or moisture.

WARNING: An apparatus with Class I construction shall be connected to a mains socket-outlet with a protective earthing connection.

2. IMPORTANT SAFETY INSTRUCTIONS

1. Read these instructions.
2. Keep these instructions.
3. Heed all warnings.
4. Follow all instructions.
5. Do not use this apparatus near water.
6. Clean only with dry cloth.
7. Do not block any ventilation openings. Install in accordance with the manufacturer’s instructions.

8. Do not install near any heat sources such as radiators, heat registers, stoves, or other apparatus (including amplifiers) that produce heat.
9. Do not defeat the safety purpose of the polarized or grounding type plug. A polarized plug has two blades with one wider than the other. A grounding type plug has two blades and a third grounding prong. The wide blade or the third prong are provided for your safety. If the provided plug does not fit into your outlet, consult an electrician for replacement of the obsolete outlet.
10. Protect the power cord from being walked on or pinched particularly at the plugs, convenience receptacles, and at the point where they exit from the apparatus.
11. Only use attachments/accessories specified by the manufacturer.
12. Unplug the apparatus during lightning sorts or when unused for long periods of time.
13. Refer all servicing to qualified personnel. Servicing is required when the apparatus has been damaged in any way, such as power supply cord or plug is damaged, liquid has been spilled or objects have fallen into the apparatus, the apparatus has been exposed to rain or moisture, does not operate normally, or has been dropped.
14. Disconnecting from mains: Switching off the POWER switch all the functions and light indicators of the amplifier will be stopped, but fully disconnecting the device from mains is done unplugging the power cord from the mains input socket. For this reason, it always shall remain readily operable.
15. Equipment is connected to a socket-outlet with earthing connection by means of a power cord.
16. The marking information is located at the bottom of apparatus.
17. The apparatus shall not be exposed to dripping or splashing and that no objects filled with liquids, such as vases, shall be placed on apparatus.

NOTE: *This equipment has been tested and found to comply with the limits for a Class A digital device, pursuant to part 15 of the FCC Rules. These limits are designed to provide reasonable protection against harmful interference when the equipment is operated in a commercial environment. This equipment generates, uses, and can radiate radio frequency energy and, if not installed and used in accordance with the instruction manual, may cause harmful interference to radio communications. Operation of this equipment in a residential area is likely to cause harmful interference in which case the user will be required to correct the interference at his own expense.*



WARNING: This product must not be discarded, under any circumstance, as unsorted urban waste. Take to the nearest electrical and electronic waste treatment centre.

NEEC AUDIO BARCELONA, S.L. accepts no liability for any damage that may be caused to people, animal or objects due to failure to comply with the warnings above.

3. IMPORTANT NOTE

Thank you for your trust in choosing our eMIMO1616 digital audio matrix. To achieve optimum operability and performance for your unit it is VERY IMPORTANT, prior to connecting, to carefully read and take into account the points specified in this manual.

In order to guarantee optimum operation for this unit, we recommend that its maintenance be carried out by our authorised Technical Services.

The eMIMO1616 comes with a 3-year warranty.

4. INTRODUCTION

The eMIMO1616 is a digital audio matrix featuring multiple inputs and outputs, which is programmable via an embedded web-server application (controlled via a standard web browser in Windows / MacOS, etc.) or via remote control through physical wall-mounted panels, messaging consoles (paging) and applications for mobile devices (Android, iOS).

Main features include:

- 4 local inputs for stereo audio, compatible with line levels and gain adjustment from -6 to +16 dB. 2xRCA and Euroblock connectors on rear panel (INPUT 1 to INPUT 4)
- 4 local inputs for mono audio, compatible with microphone and line levels, gain adjustment from 0 to +50 dB. Euroblock connectors on rear panel (INPUT 5 to INPUT 8)
- 8 remote inputs for balanced mono audio, compatible with line level. Available on RJ45 connectors on rear panel (REMOTE INPUT 1 to REMOTE INPUT 8)
- 2 local PAGER (A and B) inputs, compatible with eMPAGE messaging consoles, receiving the signal from its microphone. RJ45 connectors on rear panel (INPUT 7 to INPUT 8)
- 16 audio output channels (zone output), line level independently configurable and balanced, such as:
 - Mono outputs (1 channel per output)
 - Stereo outputs (2 channels per output, natural pairs, 1-2, 3-4, 5-6, etc.)
- 1 audio output for headphones for the MONITOR function for output zones, mini-jack connector and volume control on front panel.
- 8 REMOTE ports for connecting eMCONTROL1 wall format remote digital panels. RJ45 connectors on rear panel.

- Ethernet interface with RJ45 connector, for programming and remote control of the unit via integrated web application (embedded web server) and/or TP-NET protocol for third-party integration.
- RS-232 interface with DB9 connector, for remote control of the unit via TP-NET protocol for third-party integration.
- MUTE port for muting one or more output zones (up to 16 available) via closing of external potential-free contact.
- 16 sets of VU meter and SELECT/MUTE keys on front panel for the control and visualisation of output signals (zones) from the front panel.
- LCD screen, CONTROL key and rotary digital control (encoder) for the control of unit zone outputs from the front panel.
- DATA indicators (connection via external client devices) and ON (switched on) on the front panel.
- Processing available for inputs:
 - 3-band EQ adjustment via BASS-MID-TREBLE controls.
 - Volume adjustment and MUTE control.
 - Phase inversion
 - Noise gate (available for INPUT 5 to INPUT 8 local inputs)
 - Variable frequency high-pass filter (available for INPUT 5 to INPUT 8 local inputs)
 - Audio over audio priority function, with two levels: inputs 5 to 8 MIC/LINE can fade (or mute fully) the sound content present (program audio) in specific output zones, enabling the broadcast of emergency announcements, warnings, etc. Each of these inputs can perform this function with priority 1 (superior) or 2 (inferior). The activation modes for the priority function can be:
 - DUCKER: via audio signal detection; on reception of a valid signal and while the input in question continues. Available on local inputs 5 to 8.
 - PAGER: via selection of the output zones, pressing the PAGE key, and real-time voice-over from eMPAGE messaging consoles. Chime available as an alert prior to message voice-over, on activating PAGE function. Available on local inputs 7 and 8 (PAGER A and PAGER B, respectively)

- Processing available for outputs:
 - Mono mode (outputs managed individually) or stereo mode (outputs managed in natural pairs): 1-2, 3-4, etc.). Automatic handling of mono or stereo audio sources routed towards mono or stereo outputs.
 - Selection of program source (local or remote audio inputs)
 - 3-band EQ adjustment via BASS-MID-TREBLE controls.
 - Volume adjustment and MUTE control.
 - Limitation on available output volume range (minimum and maximum levels) for end user, from any method of control (eMCONTROL1 panels, client pilot application, etc.)
 - Phase inversion
 - Enablement for muting via MUTE port on rear panel (via closing of external contact)
- Programming and control as Administrator (admin) via the embedded web application, using a computer, tablet or mobile device, and a standard web browser (without the installation of dedicated software)
- Remote control for end users via:
 - Front control panel, with programmable access restrictions
 - eMCONTROL1 physical wall panels
 - eMPAGE (paging) messaging consoles
 - eMIMO pilot application, available for iOS and Android devices
 - Standard web browsers, via computers, tablets, etc.

Note: From the unit's embedded web application, the **admin** user can set restrictions on controls and adjustments available from the physical wall panels (eMCONTROL1) and messaging consoles (eMPAGE) for the end user, together with user accounts and the graphic control and adjustment panels that the end users can use via the **eMIMO pilot** and web applications.

5. INSTALLATION AND CONNECTION

5.1. Location, assembly and ventilation

The eMIM01616 has been specially designed for incorporation within a 19" rack, occupying 2 U's.

It is very important that, as a heat generating element, the unit is not completely enclosed or exposed to extreme temperatures. The passage of fresh air through the ventilation holes on the chassis should be ensured, by leaving at least 1 U free between each unit and those installed above and below on the rack.

If the installation includes various pieces of equipment on the same rack, or is within a cabinet with doors, then the provision of upward forced ventilation, through the fitting of fans on the lower and upper extremes, is highly recommended. The upward ventilation flow will improve the dissipation of heat generated within.

5.2. Connection to the mains supply and switching on

The eMIM01616 is powered by an AC voltage of 90 to 264V at 47 to 63Hz. The unit features an overdimensioned power supply unit capable of adapting to the supply voltage in any country in the world without the need for adjustment.

The on/off switch for the unit is on the rear panel, next to the IEC mains connector. On the front panel there is an LED **ON** indicator, which is lit when the unit is functioning.

Do not allow the supply cable to become entwined or run parallel to the shielded cables carrying the audio signal, as this could cause buzzing.

5.3. Local audio input connections

The eMIMO1616 has a rear panel with 8 **local audio inputs**, with the following connection types available:

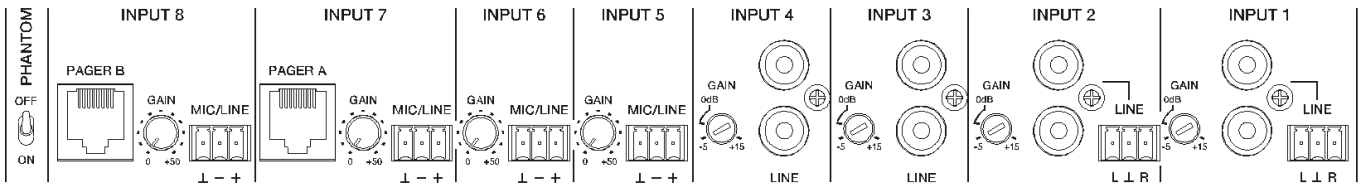

- INPUT 1 to INPUT 4: unbalanced stereo line-level signals, with double connector format (RCA and Euroblock). Use either of the connectors, based on the type of cable available between the sound source and the eMIMO1616 unit:
 - Double RCA connector: connect the stereo sound source directly (CD players, Smart phones, radio tuners, streaming players, etc.) via a cable that delivers the left (L) channels and right (R) channels to the white and red RCA connectors on the unit, respectively.
 - Euroblock connector, 3 contacts; connect the stereo sound source in this way:
 - Left channel > L Terminal
 - Right channel > R Terminal
 - Earth > ⊥ Terminal
- INPUT 5 to INPUT 8: **mono balanced** microphone or line signals, with Euroblock 3-contact connector:
 - Hot or direct signal > + Terminal
 - Cold or inverted signal > - Terminal
 - Earth > ⊥ Terminal

Note: if the sound source is stereo, and you want to connect it to one of the IN5 to IN8 local mono balanced inputs on the eMIMO1616 unit, you can do it via the following stereo to mono conversion, simply by using a pair of external resistors:

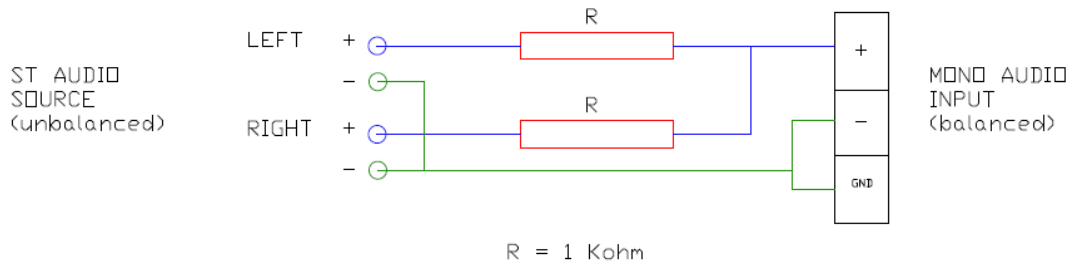

On the rear panel of the unit there is a PHANTOM ON/OFF switch, which allows the provision of a phantom power supply to inputs 5 to 8 for use with microphones (usually condenser microphones).

- In addition, there are 2 connection ports called PAGER A and PAGER B, with INPUT 7 and INPUT 8 audio inputs (respectively) duplicated for use with PAGER priority modules. These ports receive audio signals from eMPAGE messaging consoles. A standard (crossover) CAT5 or higher cable, with an RJ45 connector on each end, connects a messaging console point to point to either of ports A or B on the unit, through which the remote DC supply for the messaging console, control data, and balanced audio from the messaging console microphone can be transmitted. The maximum number of messaging consoles allowed is 2: one connected to the PAGER A port and the other to the PAGER B port.

Once the physical connections for the various audio inputs have been made, it will be necessary to adjust the GAIN control for each of them, in order to obtain a signal of maximum intensity and maximum signal / noise ratio, so that they can be correctly employed as sound sources for the installation. To that end it is necessary to maximise the volume controls for the audio players, before adjusting the gain on the eMIMO1616 unit. Use the level indicators on the front of the unit (physical VU meters), and the virtual level indicators (on-screen VU meters) from the web application in order to correctly adjust the gain, seeking to obtain signal peaks for the zone of close to 0 dB (orange zone on the virtual VU meters) with peaks above this ("red" zone, saturation or clipping) being the exception.

5.4. Remote audio input connections

The eMIMO1616 has 8 control ports (REMOTE INPUTS) with RJ45 connector, for the connection of eMCONTROL1 remote control panels. Each of these ports, in addition to providing the DC power supply and digital communication bus for the remote panels, has a balanced mono audio input with line level, taken as a **remote input** for the eMIMO1616 unit. It is thus possible to increase the number of audio inputs for the unit using these 8 remote inputs, in addition to the 8 local inputs available via audio connectors on the rear panel of the matrix.

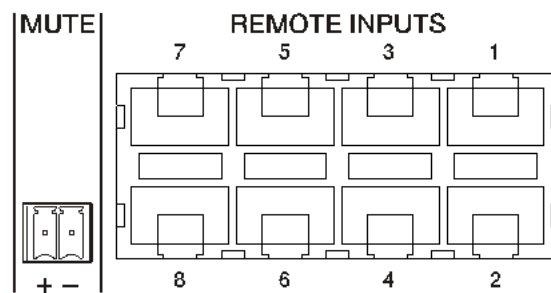

The connection of a balanced mono audio signal to a REMOTE port on the eMIMO1616 matrix is made in the following way:

- Hot or direct signal > Terminal 8 on the RJ45 connector
- Cold or inverted signal > Terminal 7 on the RJ45 connector
- Earth > Terminal 6 on the RJ45 connector

In the event of using an eMCONTROL1 remote panel to control a zone of the installation, the eMCONTROL1 panel itself has an internal connector to receive the audio signal from an adjacent, complementary panel, such as the WPaMIX-T, on the pair from the example below. This configuration type is ideal for remote control of the zone and audio from the zone itself: a single CAT5 standard cable is connected between the eMCONTROL1 panel and a REMOTE port on the eMIMO1616 unit, to provide the DC power supply, transmit digital control data, and send remote audio signals from a physical input on the eMCONTROL1 complementary panel to the eMIMO1616 unit.

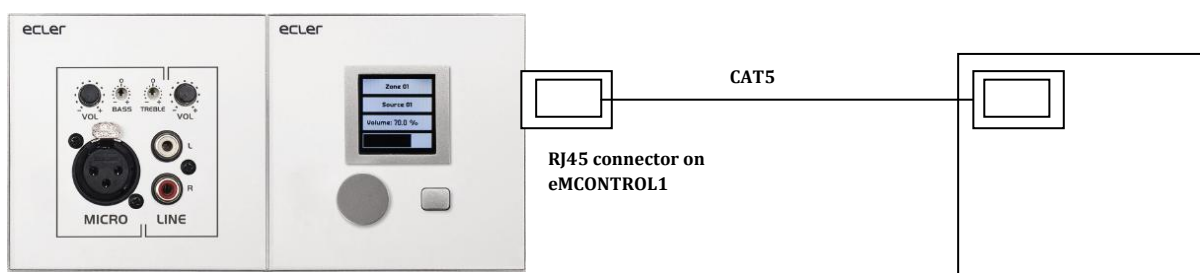

Pair of wall panels, on which eMCONTROL1 (right) receives the balanced audio from its complementary panel, WpaMIX-T (left)

eMIMO1616
REMOTE ports

5.5. PAGER A, PAGER B connections and priority PAGER / DUCKER modules

In the local inputs section on the rear panel there are 2 ports called PAGER A and PAGER B, with audio inputs internally matching INPUT 7 and INPUT 8 (respectively).

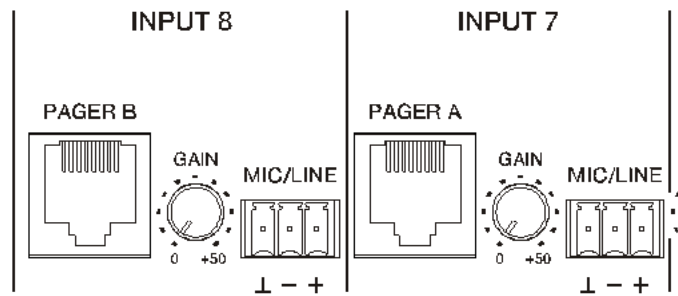

The PAGER ports are used for point to point connection to 2 eMPAGE messaging consoles, through which it is possible to perform functions such as real-time voice calls (paging) to output zones within the installation, using a priority module on the eMIMO1616 unit which fades or fully mutes the sound content of the existing program in those zones at the time of the action.

A standard (crossover) CAT5 or higher cable, with an RJ45 connector on each end, connects a messaging console point to point to either of ports A or B on the unit, through which the remote DC supply for the console, control data, and balanced audio from the messaging console microphone can be transmitted.

A maximum of 2 consoles is allowed; one connected to the PAGER A port, and the other to the PAGER B port, with each one using a PAGER priority module on the eMIMO1616 unit.

Note: it is not possible to perform **the following connections simultaneously**, and the connections listed below are mutually **exclusive**:

- a messaging console to the PAGER A port + an audio signal to the INPUT7 Euroblock connector
- a messaging console to the PAGER B port + an audio signal to the INPUT8 Euroblock connector

The total number of PAGER (to messaging console) or DUCKER (without messaging console) priority modules for the eMIMO1616 is 4, assignable to the local inputs 5 to 8. These 4 modules may be activated or deactivated, and each of them may use one of the 2 available priority levels, so that the signals with greater priority will fade the program signal selected in the destination zone, in addition to the signals of lesser priority sent to these zones, if there are any, at the time when the maximum priority module is activated.

See the eMIMO1616 [web application manual](#) to find out more about programming the PAGER / DUCKER priority modules.

5.6. REMOTE INPUTS 1 to 8 connections

On the eMIMO1616 rear panel there are 8 control ports, REMOTE INPUTS 1 to 8, which are enabled for the connection of eMCONTROL1 zone control wall panels. Each port has an RJ45 connector, and each eMCONTROL1 panel also has an RJ45 connector, such that the physical connection between a remote panel and a REMOTE port on the eMIMO1616 unit can be made, point to point, via a CAT5 standard or higher (crossover) cable.

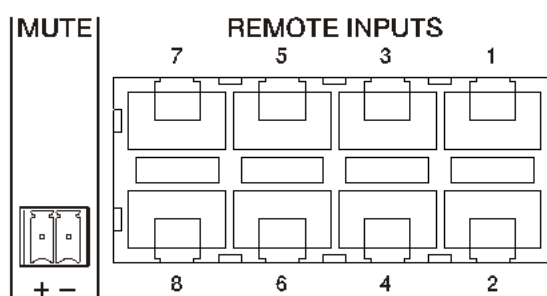

This physical connection provides a DC power supply to the remote panel from the eMIMO1616 unit, and establishes a digital communication bus between the two pieces of equipment. It also allows the reception of balanced mono audio from a potential remote sound source (connected on the side of the control panel) on the eMIMO1616 unit.

The wall control panels are configured by the Administrator user via the eMIMO1616 web application (see [web application manual](#) for the eMIMO1616), so that it is possible to fully disable them, or enable them to function as user controls for an installation zone, including all or some of the following functions:

- Selection of sound source (program audio), from a customised list for each panel that includes some local sources and/or the remote source itself.
- Volume adjustment (with a maximum and minimum adjustment margin) and mute control
- Equalisation adjustment, with 3-band EQ (BASS-MID-TREBLE).

Alternatively, these inputs may receive, exclusively, a balanced mono signal via the RJ45 connector, while respecting the corresponding assignation of pins (see section 3.4):

- Hot or direct signal > Terminal 8 on the RJ45 connector
- Cold or inverted signal > Terminal 7 on the RJ45 connector
- Earth > Terminal 6 on the RJ45 connector

5.7. REMOTE PORTS, RJ45 interface pinout

- **Pin 1:** audio hot or direct signal
- **Pin 2:** audio cold or inverted signal
- **Pin 3:** ground
- **Pins 4 & 5:** digital data bus
- **Pin 6:** +12 VDC supply
- **Pin 7:** unused
- **Pin 8:** ground

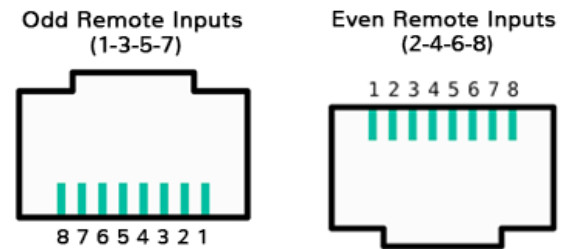

5.8. Audio output connections

The eMIM01616 has 16 audio output channels (zone outputs), with independently configurable balanced line, such as:

- mono outputs (1 channel per output)
- stereo outputs (2 channels per output, natural pairs, 1-2, 3-4, 5-6, etc.)

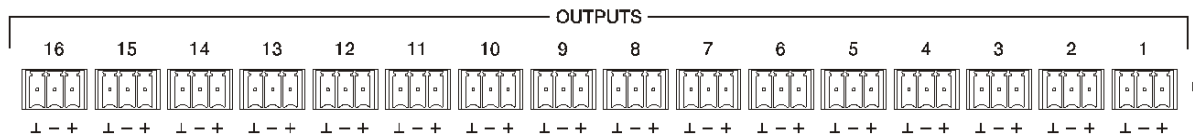

Each output has a 3-contact Euroblock connector,

- Hot or direct signal > + Terminal
- Cold or inverted signal > - Terminal
- Earth > ⊥ Terminal

In the event of connecting an output channel to an amplifier or audio device with **balanced** input, it is recommended to connect terminals +, - and ⊥ point to point between the two units. In the event of connecting an output channel to an amplifier or device with an **unbalanced** audio input, do not connect the - terminal.

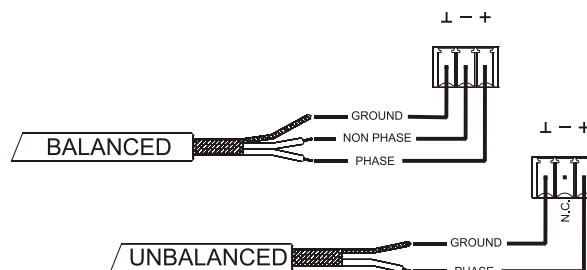

MONITOR output (marked with a headphones symbol): 3.5mm stereo mini-jack connector with rotary level control to listen via headphones. It is particularly useful for listening to output signals from the unit without disturbing its normal operation. The selection of the signal to listen to is made via the front panel, simply

by pressing the “select” button for the zone you wish to monitor. The volume control for the headphones signal is after the volume control for the zone, so that the volume of the zone, or whether it is in MUTE, will have to be taken into account.

5.9. ETHERNET and RS-232 ports for programming and control

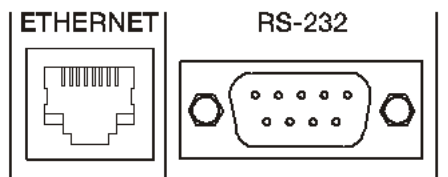

The RJ45 ETHERNET connector on the rear panel allows the connection of the unit to an Ethernet network, either directly to a computer or to another device with an Ethernet interface, point to point. This connection enables, within a local network, the following:

- The Programming and overall management of the eMIMO1616 unit via the embedded web application and a standard web browser running on a computer, a tablet, etc.
- The connection of client devices for the end user in installation zones via the eMIMO pilot application, which is compatible with Android and iOS, or via standard web browsers running on computers, tablets, etc.
- The connection of third-party equipment for integration within control systems (Crestron®, Extron®, AMX®, Vity®, Medialon®, etc., brands registered by their manufacturers), using the TP-NET protocol embedded in the eMIMO1616. See the TP-NET protocol manual for further information.

The DB9 RS-232 connector on the rear panel allows the connection of the unit point to point to a computer or other control device. This connection exclusively uses the integration via series port with third-party equipment and control systems (Crestron®, Extron®, AMX®, Vity®, Medialon®, etc., brands registered by their manufacturers), using the TP-NET protocol embedded in the eMIMO1616. See the [TP-NET protocol manual](#) for further information.

The parameters necessary for a correct series connection are the following:

- Baud rate: 115200 (fixed, no autonegotiation)
- Data bits: 8
- Parity: None
- Stop bits: 1

- Flow control: None

5.10. MUTE port

The eMIMO1616 has a control input, or MUTE port, on the rear panel, which allows the enabling / disabling of mute for audio outputs (zones) from the unit via a button, relay or the closing of an external potential-free contact.

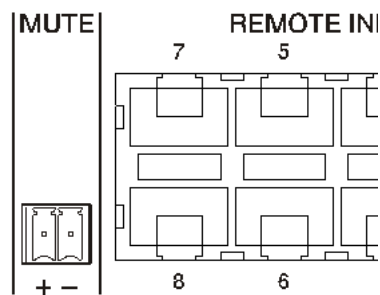

The allocation of outputs affected by the MUTE port is set via the eMIMO1616 web application. See the [eMIMO1616 web application](#) manual for further information.

6. CONFIGURATION AND CONTROL

6.1. Configuration via embedded web application

Once the physical connections have been made, the eMIMO1616 must be configured via the embedded web application, from a computer, tablet, or similar device on which it is possible to open a standard web browser, connected to the IP address of the unit (by default 192.168.0.100, but may be changed). This task is reserved exclusively for the system installer or Administrator, who must be identified by “**admin**” user credentials:

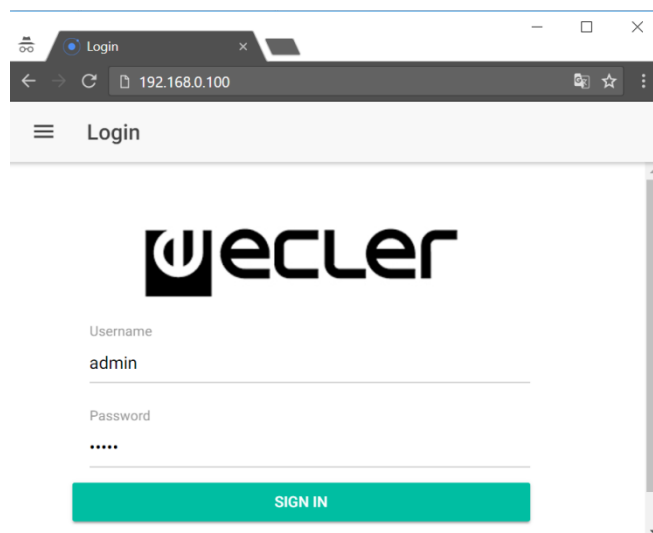

See the [eMIMO1616 web application](#) manual for full information regarding configuration of the unit.

Note: the eMIMO1616 has an information screen which is activated by pushing and holding simultaneously (>3 seconds) the CTRL key and the encoder on the front panel:



The screen shows the following information:

- Firmware version being used by the unit
- NAME: name of the eMIMO1616 unit
- Network connection parameters: IP address, subnet mask and network gateway
- Bank1: memory bank in use (1 or 2). Useful information for the detection of and solution for various problems with the unit
- Admin: number of admin users connected to the unit (0 or 1)
- Users: numbers of client users, via the eMIMO pilot application or web browsers (0 to 20)

The main parameters, settings and functions which are accessible on the eMIMO1616 from its web application are:

- General configuration; unit name, network parameters, recording and recovery of projects (overall equipment configuration), start mode, firmware updates, default parameter reset, connection status, etc.

- Management of user accounts, which will allow access to external clients (end users) via the *eMIMO pilot* application or web browsers: names, passwords and enabled / disabled status
- Front panel parameters:
 - adjustments to LCD screen: brightness, contrast, stand-by mode
 - overall access / blocking (for all front controls)
 - individual access / blocking for specific controls, and for specific output zones. It is possible to allow access to the settings for some zones and block them for others, or even decide which parameters are accessible for each of them: volume adjustment and MUTE and/or selection of sound source and/or equalisation via 3-band EQ (BASS-MID-TREBLE)
- Local and remote audio input parameters; names, polarity, volume, MUTE, equalisation via 3-band EQ (BASS-MID-TREBLE), noise gate, high-pass filter, etc.
- Parameters for audio output (zones): names, mono / stereo mode, polarity, selection of sound source, volume, accessible volume range for end users (maximum and minimum levels), MUTE, equalisation via 3-band EQ (BASS-MID-TREBLE), noise gate, high-pass filter, effect of MUTE port activation (closing of external contact), etc.
- Configuration of the 4 PAGER / DUCKER priority modules (with eMPAGE messaging consoles / activated via audio level detection on the input in question, respectively)
- Configuration of the eMCONTROL1 physical control panels connected to the eMIMO1616 unit; connection status, enabled / disabled status; zone under control, enabled functions (volume adjustment and MUTE and/or selection or sound source and/or equalisation via 3-band EQ (BASS-MID-TREBLE), etc.
- Creation, edition and configuration of the pilot panels, accessible from external devices via the eMIMO pilot application or web browsers: public or private panel (accessible only for specific users), enabled / disabled status, zone under control, enabled functions (volume adjustment and MUTE and/or selection or sound source and/or equalisation via 3-band EQ (BASS-MID-TREBLE), graphical appearance (control types, slider or rotary, control colours, texts and background), etc.

6.2. Front panel control

Using the physical controls on the front panel of the eMIMO1616 it is possible to make adjustments to the various output zones from the unit. The settings available for the various zones will be those that the *admin* user enabled via the web application, and may range from blocking the entire front panel to complete

freedom to control all zones (volume adjustment, source selection and equalisation adjustment), or the total or partial blocking of some of them.

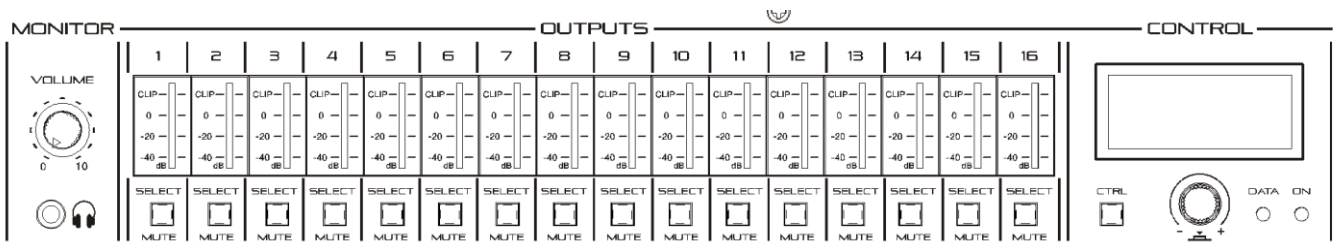

Pressing a SELECT key corresponding to one of the outputs on the unit allows it to be controlled via the CTRL key, the **encoder** and the LCD screen on the right of the front panel. In addition, the LED indicator on the SELECT key pressed will flash with a fixed rhythm (long off, short on), indicating that the output has been selected for control. After a few seconds without changing the front controls, in other words, without making any adjustments, the key will stop flashing.

Example pressing the SELECT key for output 1 or 2 (the same effect in this case, as they are set as a stereo pair):



Example pressing the SELECT key for output 3:



In the upper images you can see:

- 2 level indicators or VU meters (vertical bars): the one on the left of the screen shows the level of the sound sources selected for the selected zone (pre-fader), and the one on the right shows the level of the output signal for the zone (post-fader)
- First line of text: output number (zone) selected
- Second line of text: name (tag) for the selected zone
- SRC: selected sound source
- VOL: set output volume

The flashing box above SRC or VOL, in addition to the line of text in bold on a light background, indicate which function is at that moment **focussed**, or ready for

setting. The lower image shows the VOL control, which allows adjustment of the output volume via an encoder, and within a predefined range (set by the *admin* user) for the selected output:



On the screen, a long press (>3 seconds) of the encoder, or a long press of the SELECT key enables / disables the MUTE function for the zone in question:



Note: on the muted outputs (MUTE function enabled):

- A muted output, not selected for adjustment, will have its SELECT/MUTE key lit continuously (no flashing)
- A muted output which is at the same time selected for adjustment, will have its SELECT/MUTE key flashing with a fixed rhythm, but opposite to the rhythm of an unmuted output selected for adjustment

Pressing the CTRL key quickly changes the focus to the other available function, in this case, to the SRC function, or the sound source selection:



Then, turning the encoder allows the selection of one of the available sound sources, with confirmation of selection by pressing the encoder:



A long press of the CTRL key jumps to the equalisation screen for the zone:



On the screen, the selected tone control is indicated by the flashing rectangle around the text BASS, MID or TREBLE, and adjustment is carried out by turning the encoder:



Short presses of the CTRL key allow another equalisation control to be highlighted:



Another long press of the CTRL key, or a period of inactivity of 10 seconds, returns the screen to its previous status, showing main data for the zone under control:



All the previously described controls for the specific zone (VOL, SRC, BASS, MID and TREBLE) will be shown and available for adjustment only if the **admin** user has enabled the front panel for this, and a zone may be partially or fully blocked for control via the front panel.

When a specific function for a zone is disabled for adjustment via the front panel, if this adjustment is attempted the following message will appear on the LCD screen:



When the front panel is fully blocked (disabled) for use, on pressing any key the following message will appear on the LCD screen:



7. FUNCTION LIST

1. Headphones volume control
2. Headphones output: stereo Jack 6,3mm
3. LED vumeter (CH1 – CH16)
4. SELECT button / MUTE (CH1 – CH16)
5. Control button, CTRL
6. Digital rotary control (encoder)
7. Data traffic LED indicator, DATA
8. Power on LED indicator, ON
9. LCD screen
10. Mains switch, POWER
11. Fuse holder
12. Mains socket
13. External mute terminal, MUTE
14. Remote control / audio ports (connection to eMCONTROL1)
15. RJ-45 connector, ETHERNET
16. Remote PAGER ports (connection to eMPAGE paging stations) (IN7 – IN8)
17. Input gain adjust, GAIN (IN7 – IN8)
18. Input micro & line (Euroblock) connector, MIC/LINE (IN7 – IN8)
19. RS-232 connector (TP-NET protocol)

20. Input gain adjust, GAIN (IN5 – IN6)
21. Input micro & line (Euroblock) connector, MIC/LINE (IN5 – IN6)
22. Input gain adjust, GAIN (IN3 – IN4)
23. Input line (RCA) connector, LINE (IN5 – IN6)
24. Input gain adjust, GAIN (IN1 – IN2)
25. Input line (RCA) connector, LINE (IN1 – IN2)
26. Input line (Euroblock) connector, LINE (IN1 – IN2)
27. Output (Euroblock) connectors, OUTPUTS

8. FUNCTION DIAGRAM

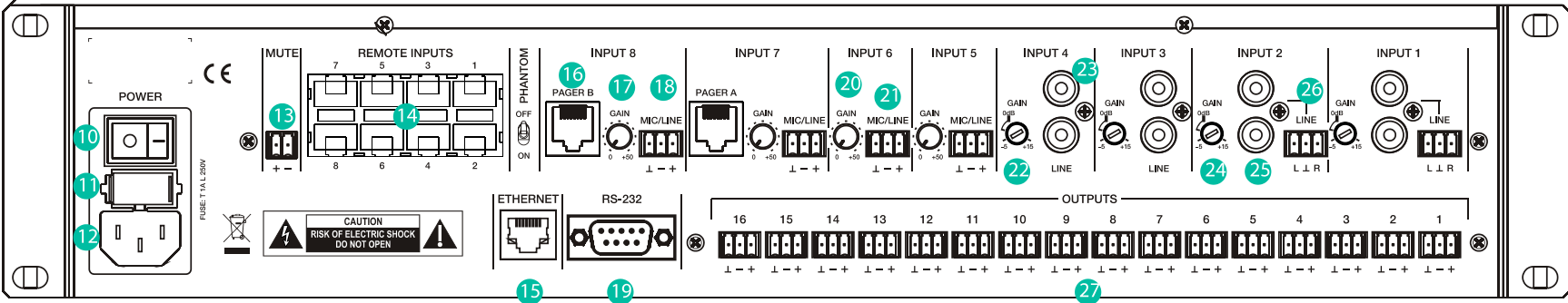
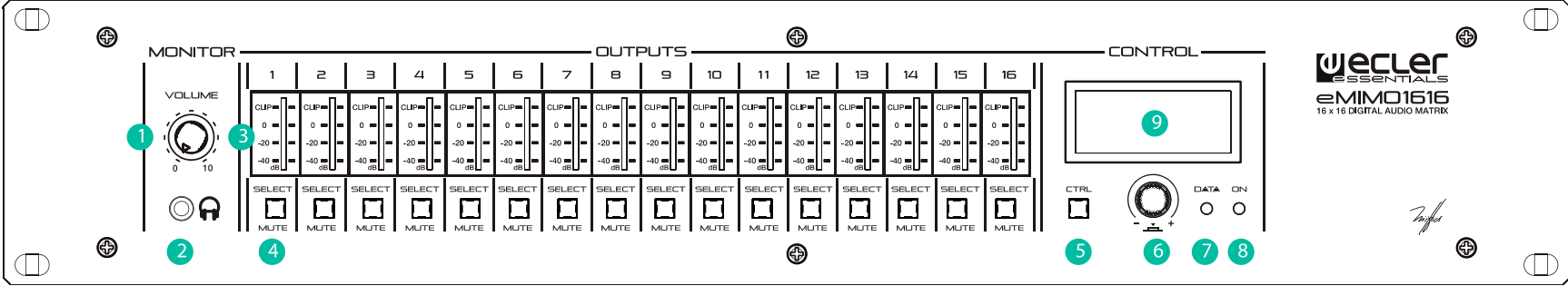

9. BLOCK DIAGRAM

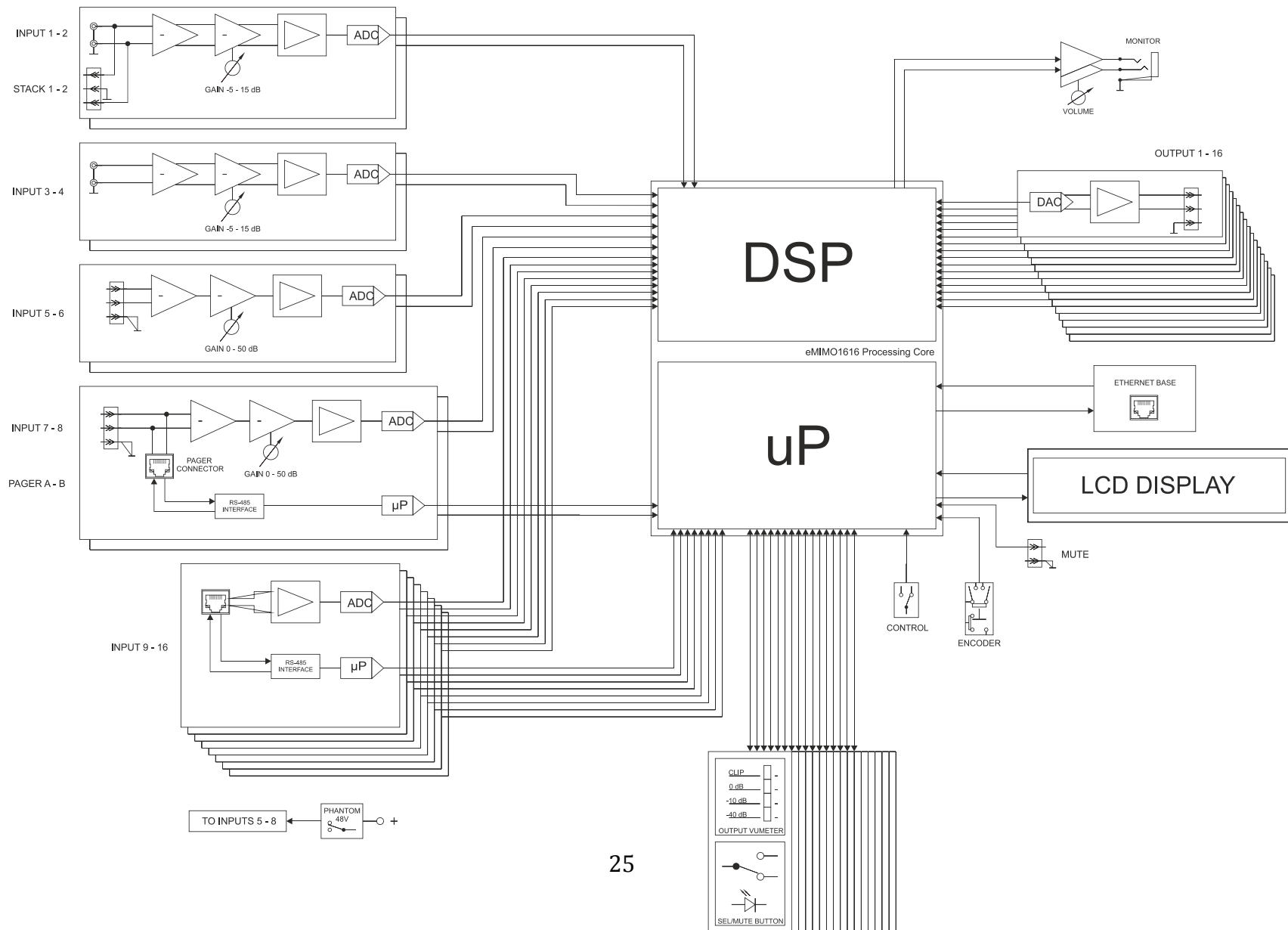

10. TECHNICAL CHARACTERISTICS

DSP	
DSP	Floating point 32/64bit
Sampling Rate	48kHz
Latency IN to OUT	<1.5ms
AD/DA Converters	
Resolution	24bit AKM
Dynamic Range	AD:111dB, DA: 115dB
Analogue	
Input 1-4 (LINE)	Sensitivity: +5 / -15dBV External potentiometer adjust Input impedance: >13k Input connector: RCA female. Input 1 and 2 with EUROBLOCK stack Input type: Unbalanced
Input 5-8 (MIC/LINE)	Sensitivity: +0 / -50dBV External potentiometer adjust Input impedance: >24k electronically balanced CMRR: >60dB (20Hz ÷ 20kHz) Input connector: Terminal block (Symmetrical) Pagers: Input 7 and 8 (by RJ45 connector) Input type: Balanced Phantom voltage: +48VDC
Input 9-16 (Remote)	Sensitivity: 0 dBV without adjustment. Input impedance: >24k electronically balanced CMRR: >60dB (20Hz ÷ 20kHz) Input connector: RJ45 Connector Input type: Balanced
External MUTE	Normally open. Assignable to any output zone
Frequency response (+0dB / -0.5dB)	<10Hz ~ 20kHz
Flatness	better than ±0.1dB
THD+Noise @ 1kHz, 1Vrms	< 0.005%
Output Noise floor FFT (20Hz - 20kHz)	>110dB
Interchannel crosstalk (20Hz - 20kHz)	> 90dB
CMRR 20Hz- 20kHz	>60dB typical
Processing	
Input Level (x16)	Volume: From Off to 0 dB MUTE: Yes Polarity: Yes HPF (inputs 5-8): 50Hz to 150Hz – 3dB Metering: VuMeter post Fader Stereo: On – Off
Input Noise Gate (x4)	Inputs: Input 5 to 8, Bypass ON - OFF Threshold: From -80dBV to +12dBV Depth: From 0 dB to 80 dB Attack: From 0.1ms to 500ms Hold: From 10ms to 3000ms Release: From 10ms to 1000ms
Input EQ (x16)	Type: Baxandall 3 ways EQ Gain: -10dB ~ +10dB in 0.1dB steps Frequency: Low 200Hz Mid 1kHz High 6.3kHz
Output Level (x16)	Volume: From Off to 0 dB MUTE: Yes Polarity: Yes Metering: VuMeter post Fader Stereo: On – Off
Ducker (x4)	Input: IN5 to IN8. In 7 and 8 selectable from DUCKER to PAGER Outputs: Selectable by Duckers/Pagers panel Priority: Four levels (1 – 4) Depth: 0dB to 80 dB Attack time: 5ms to 2000ms Release time: 50ms to 3000ms Threshold: -80dBV to +12dBV Hold time: 10ms to 3000ms

Pager (x2)	<p>Input: IN7 and 8, selectable from PAGER to DUCKER</p> <p>Outputs: Selectable by Duckers/Pagers panel</p> <p>Priority: Four levels (1 – 4). 1 max, 4 min</p> <p>Functions: Two function buttons (F1, F2)</p> <p>Depth: 0dB to 80 dB</p> <p>Attack time: 5ms to 2000ms</p> <p>Release time: 50ms to 3000ms</p> <p>Chime volume: -12dBV to +0dBV</p> <p>Chime melody: None, Melody 1, Melody 2</p>
Pilot panels	<p>General: ON-OFF, Public, Label, Users and Zone</p> <p>Volume control: ON-OFF, Label and Style</p> <p>Source selection: ON-OFF, Label and Allowed sources</p> <p>Equalizer: ON-OFF, Label, and Style</p> <p>Color: Controls, Text and Background</p>
Mechanical	
Dimensions (WxHxD)	482.6x88x210 mm / 19x3.5x8.3 in
Weight	3.7 kg / 8.1 lb
Supply	
Mains	90-240VCA 50-60Hz
Power consumption	20W
Miscellaneous	
Management Connectivity	Ethernet Base-Tx 10/100Mb Auto X-Over CAT5 up to 100m
Remote Bus	RS485
Aux. Power Supply for Remotes	+12VDC, 0,6A. max. (short circuit protected)
Management control	Web APP, Android and iOS APP, TPNET and RS232

All product characteristics are subject to variation due to production tolerances. **NEEC AUDIO BARCELONA S.L.** reserves the right to make changes or improvements in the design or manufacturing that may affect these product specifications.

Motors, 166-168 08038 Barcelona - Spain - (+34) 932238403 information@ecler.es www.ecler.com