



**Portability · Simplicity · Flexibility**

**MA-303**

**Personal Wireless Public Address System**

**User Guide**



**MIPRO** MIPRO Electronics Co., Ltd.

Headquarters: 814 Pei-Kang Road, Chiayi, 60096, Taiwan.

Web: [www.mipro.com.tw](http://www.mipro.com.tw)

E-mail: [mipro@mipro.com.tw](mailto:mipro@mipro.com.tw)

CE FC



## **! IMPORTANT SAFETY INSTRUCTIONS !**

1. Read these instructions.
2. Keep these instructions.
3. Heed all warnings.
4. Follow all instructions.
5. Do not use this apparatus near water.
6. Clean only with a dry cloth.
7. Do not block any ventilation openings. Install in accordance with the manufacturer's instructions.
8. Do not install near any heat sources such as radiators, heat registers, stoves, or other apparatus (including amplifiers) that produce heat.
9. Do not defeat the safety purpose of the polarised or ground plug: A polarised plug has two blades with one wider than the other. The wide blade is provided for your safety. When the provided plug does not fit into your outlet, consult an electrician for replacement of the obsolete outlet.
10. Protect the power cord from being walked on or pinched particularly at plug, convenience receptacles, and the point where they exit from the apparatus.
11. Only use attachments/accessories specified by the manufacturer.
12. Use only with a cart, stand, tripod, bracket, or table specified by the manufacturer, or sold with the apparatus. When a cart is used, use caution when moving the cart/apparatus combination to avoid injury from tip-over. 
13. Unplug this apparatus during lightning storms or when unused for long periods of time.
14. Refer all servicing to qualified service personnel. Servicing is required when the apparatus has been damaged in any way, such as power-supply cord or plug is damaged, liquid has been spilled or objects have fallen into the apparatus, the apparatus has been exposed to rain or moisture, does not operate normally, or has been dropped.
15. To reduce the risk of fire or electric shock, do not expose this apparatus to rain or moisture.
16. Apparatus should not be exposed to dripping or splashing and no objects filled with liquids, should be placed on the apparatus.
17. Use only with the battery which specified by manufacturer.
18. The power supply cord set is to be the main disconnected device.

## **WARNING**

1. **FOR OUTDOOR USE:**  
To reduce the risk of fire or electric shock, do not expose this apparatus to rain or moisture.
2. **UNDER WET LOCATION:**  
Apparatus should not be exposed to dripping or splashing and no objects filled with liquids, such as vases should be placed on the apparatus.
3. **SERVICE INSTRUCTIONS:**  
CAUTION - These servicing instructions are for use by qualified service personnel only. To reduce the risk of electric shock, do not perform any servicing other than that contained in the operating instructions unless you are qualified to do so.

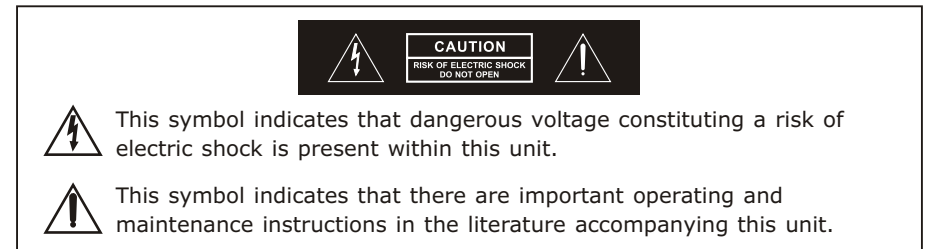

## **FC & IC - ID**

THIS DEVICE COMPLIES WITH PART 15 OF THE FCC RULES AND RSS-123 ISSUE2 OF CANADA. OPERATION IS SUBJECT TO THE FOLLOWING TWO CONDITIONS:

- (1) This device may not cause interference.
- (2) This device must accept any interference, including interference that may cause undesired operation of the device. This equipment complies with FCC RF radiation exposure limits set forth for an uncontrolled environment.

## **Disposal**

Dispose of any unusable devices or batteries responsibly and in accordance with any applicable regulations.

Disposing of used batteries with domestic waste is to be avoided!

Batteries / NiCad cells often contain heavy metals such as cadmium(Cd), mercury(Hg) and lead(Pb) that makes them unsuitable for disposal with domestic waste. You may return spent batteries/ accumulators free of charge to recycling centres or anywhere else batteries/accumulators are sold.

By doing so, you contribute to the conservation of our environment!



2005-08-13

**CONTENTS**

- 1 Accessories
- 2 Key Features and Benefits
- 3 Controls and Indicators
- 5 Control Panel and Displays
- 7 USB Display Screen
- 10 USB Remote Controls and Indicators
- 11 Replacing USB Remote Battery
- 12 Replacing the Rechargeable Battery
- 15 System Channel Set-Up
- 18 ACT Synchronization (sync) Between Receiver and Transmitter Channels
- 19 Operating Instructions
- 21 USB Drive Operation
- 22 Connection to External Audio Sources
- 23 Four Available Configurations
- 25 Troubleshooting-Portable Public Address
- 26 Troubleshooting-Wireless Microphone Systems
- 29 Rechargeable Battery Guide
- 30 Optional MA-303 Accessories
- 30 MIPRO Wireless Microphone Systems for MA-303
- 31 Technical Specifications

**ACCESSORIES**

The following accessories are included:

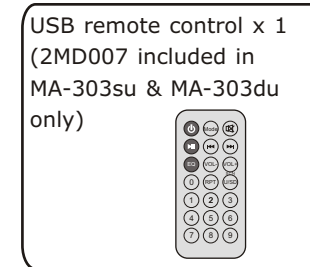
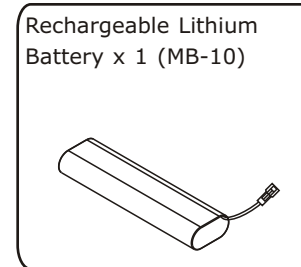
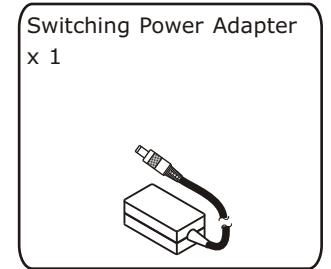
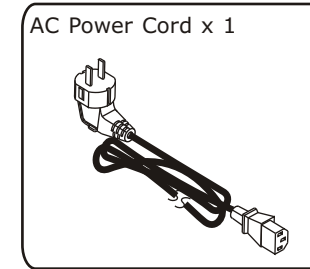
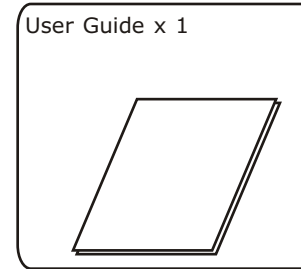

## KEY FEATURES AND BENEFITS

- It is ultra light, ultra compact, powerful and perfect multi-function Portable Wireless PA System in the market.
- Built-in 1 or 2 wireless receivers with 16 preset channels.
- User-friendly control panel with one-touch Scan & ACT sync button for simple channel set-up.
- Built-in antenna prevents from breakage and increases reception range.
- Accepts wired & wireless microphone. Optional USB music player & recorder with LCD screen.
- Built-in alarm siren provides emergency warnings.
- High efficiency class-D amplifier drives two-way loudspeaker with level limiter.
- 2 power modes: AC and lithium rechargeable battery.
- 10~16 hours of stand-by time per 4-hour full charge.
- 4 LEDs array indicator for battery levels and charging status.
- 3.5 mm line-in accepts external MP3, iPod & CD player.
- Available in four configurations.

## CONTROLS AND INDICATORS

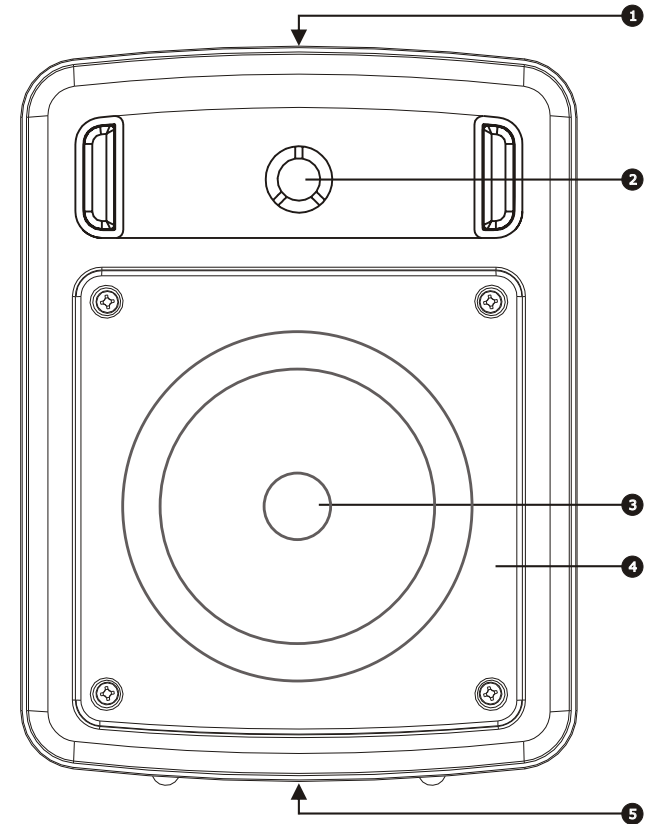

- ❶ **Fixed Carry Handle**
- ❷ **Treble Speaker:** 1-inch.
- ❸ **Bass Speaker:** 5-inch full range high efficiency.
- ❹ **Speaker Grille:** To protect the loudspeakers.
- ❺ **Mic Stand Adapter:** For mounting onto a microphone stand (15.8mm/ 3/8”).

## CONTROLS AND INDICATORS

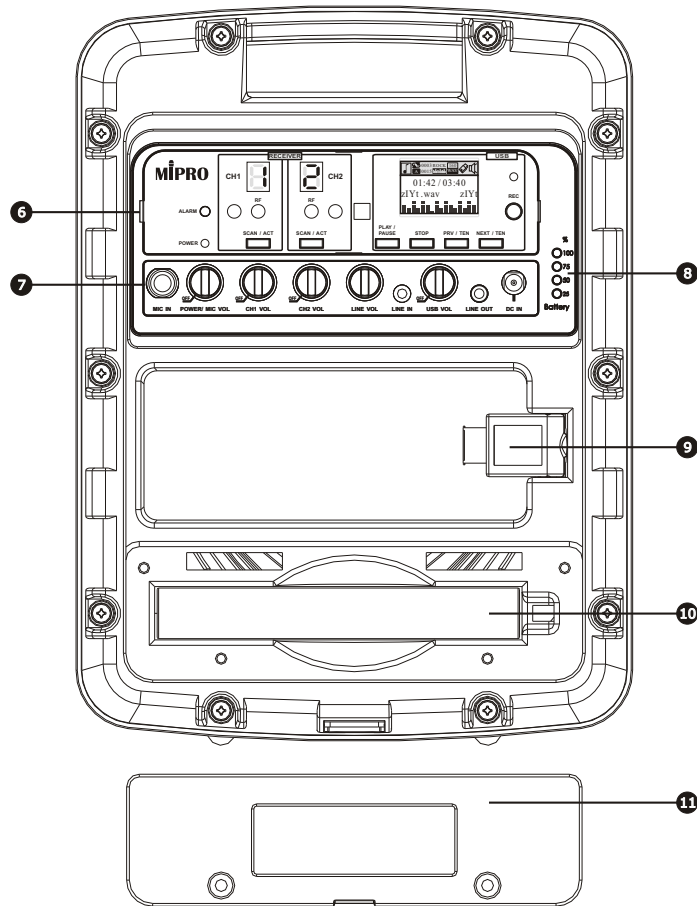

Model Shown: MA-303du

- 6 **Display Panels and Screens**
- 7 **Power/Volume Control Panel**
- 8 **Battery Meter:** Displays current & charging battery level. Blinking (charging in progress); Illuminated (battery is fully charged)
- 9 **USB 2.0 Port**
- 10 **Rechargeable Battery & Compartment**
- 11 **Battery Cover:** Protects the rechargeable battery.

## CONTROL PANEL AND DISPLAYS

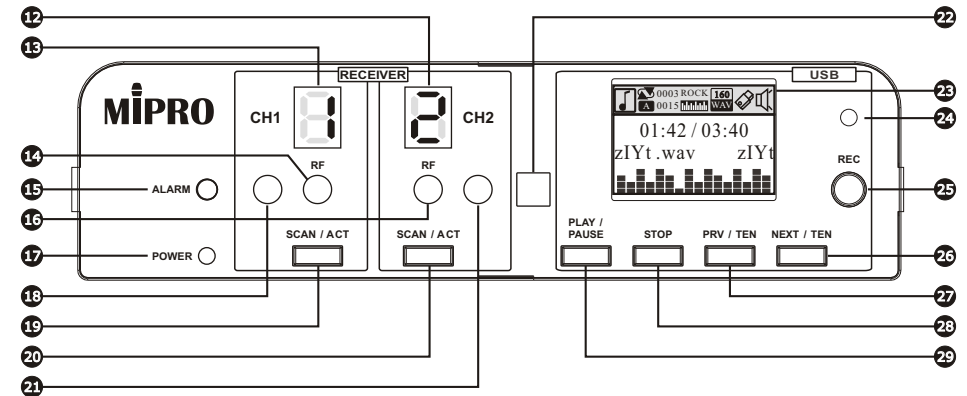

- 12 **CH2 Channel Screen**
- 13 **CH1 Channel Screen**
- 14 **CH1 RF indicator:** Glows green indicates a RF link from transmitter to receiver.
- 15 **Alarm Siren Button:** Provide warning of approaching or presence of threats or situations requiring immediate attention.
- 16 **CH2 RF indicator:** Glows green indicates a RF link from transmitter to receiver.
- 17 **Power indicator:** Glows red when master power is on and ready for operation
- 18 **CH1 Sync Port:** Uploads infrared signal to transmitter.
- 19 **SCAN / ACT CH1:** Scans for an interference-free frequency & Synchronizes the receiver and transmitter frequencies.
- 20 **SCAN / ACT CH2:** Scans for an interference-free frequency & Synchronizes the receiver and transmitter frequencies.
- 21 **CH2 Sync port:** Uploads infrared signal to transmitter.
- 22 **USB Remote Port**
- 23 **USB Display Screen**
- 24 **REC indicator**
- 25 **REC button**
- 26 **NEXT / TEN button:** Skips to next track & fast forward 10 tracks.
- 27 **PRV / TEN button:** Skip to previous track & fast rewind 10 tracks.
- 28 **STOP button:** Stops the track.
- 29 **PLAY / PAUSE button:** Plays or pauses the track.

**Power/Volume Control Panel**

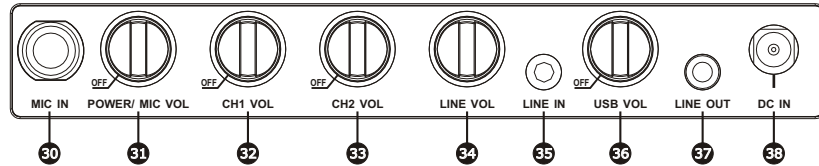

- 30 **MIC IN:** Standard 6.3mm (1/4") microphone level input jack. Accepts a MIPRO MM-107 (not included) wired dynamic microphone.
- 31 **POWER / MIC VOL:** Master power on/off and microphone volume.
- 32 **CH1 VOL:** Powers receiver on/off and wireless CH 1 volume.
- 33 **CH2 VOL:** Powers receiver on/off and wireless CH 2 volume.
- 34 **LINE VOL:** Controls the volume level of line-input.
- 35 **LINE IN:** 3.5mm (1/8") mini-jack input. Accepts external CD/MP3/iPod/cassette/VCR/DVD player, musical instruments, computer sound card or other line-level signal source.
- 36 **USB VOL:** Powers USB on/off and USB player volume.
- 37 **LINE OUT:** 3.5mm (1/8") mini-jack output. Connects to another powered PA system or external recordings.
- 38 **DC IN:** Connects the supplied switching power adaptor to recharge the battery or to supply power to the system.

**USB DISPLAY SCREEN**

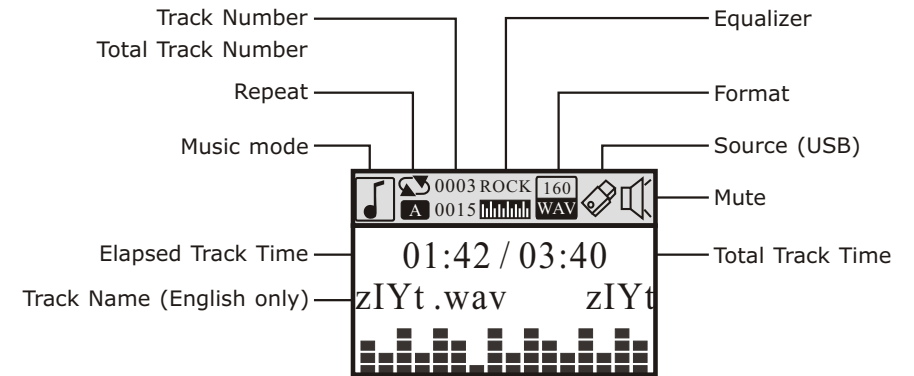

Press **PLAY/PAUSE** button to pause track



**USB** is not inserted

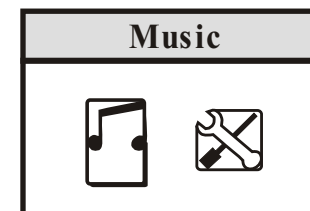

## Personal Wireless Public Address System

Change "Repeat" Parameter

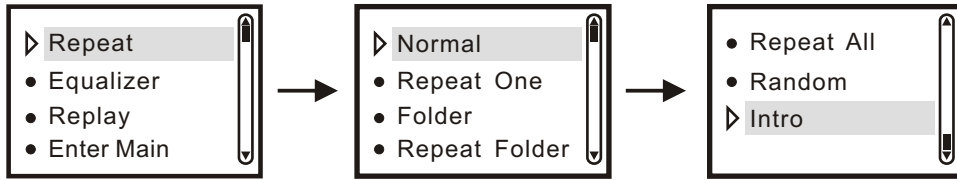

Change "Equalizer" Parameter

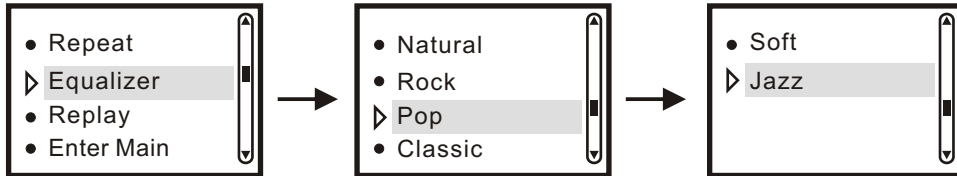

Replay "A → B" Tracks

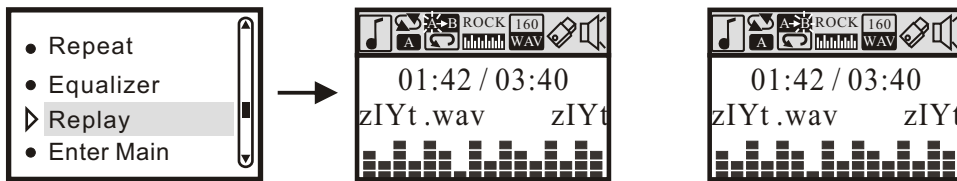

Display Music and System Set-up modes

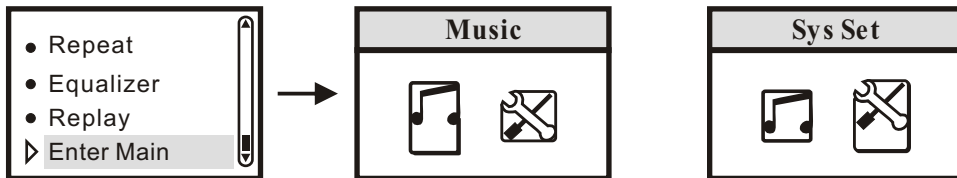

Leave "Exit" Mode

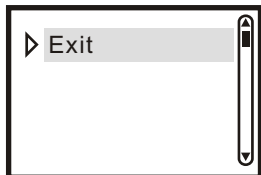

## Personal Wireless Public Address System

Change "Time" Parameter

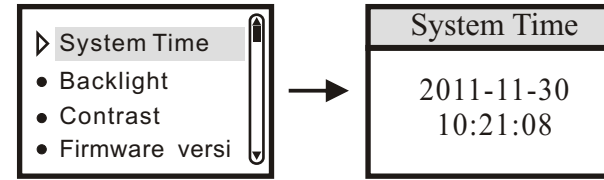

Adjust "Backlight" dimmer or brighter

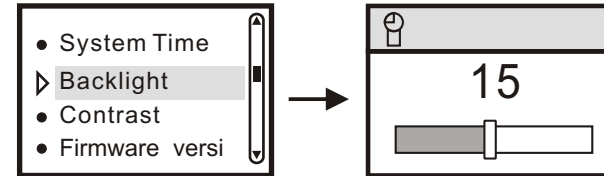

Adjust LCD "Contrast" lighter or darker

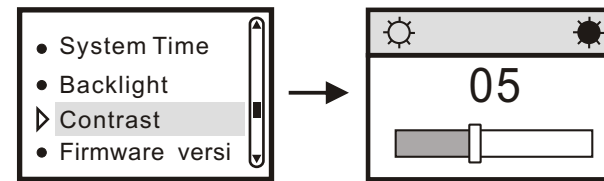

Display "Firmware" Version

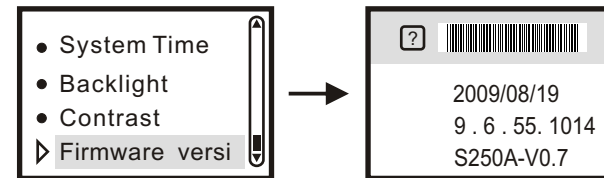

Leave "Exit" Mode

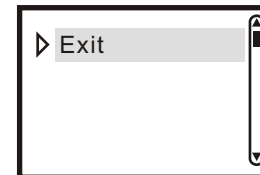

### USB REMOTE CONTROLS AND INDICATORS

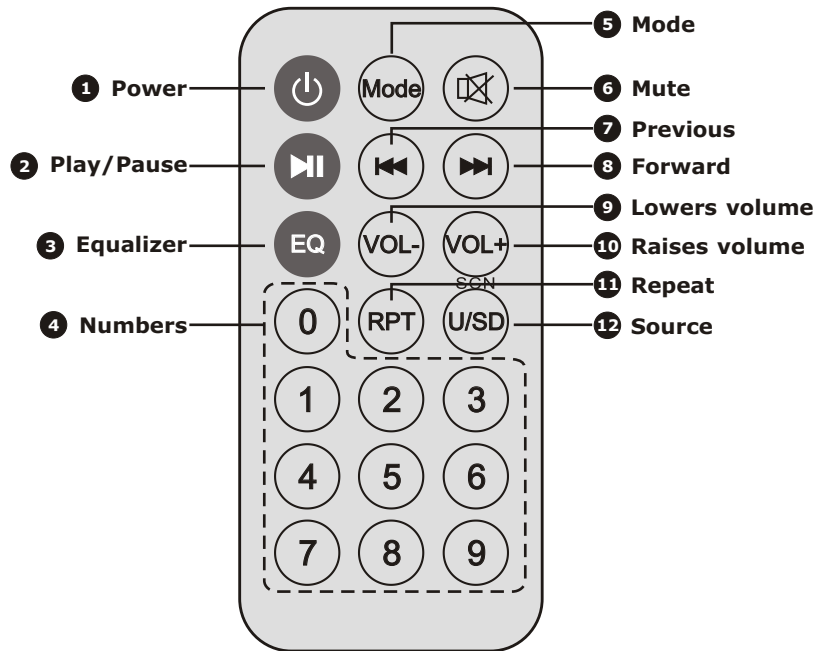

- ❶ **Power** : Turns the USB player on/off
- ❷ **Play/Pause** : Turns on play or Pauses
- ❸ **Equalizer** : Equalizer effects
- ❹ **Numbers** : 0 ~ 9 ( 10 numbers)
- ❺ **Mode** : Mode selection
- ❻ **Mute** : Mutes the audio
- ❼ **Previous** : Previous track - Press & release  
Fast rewind 10 tracks - Press & hold
- ❽ **Forward** : Next track - Press & release  
Fast forward 10 tracks - Press & hold
- ❾ **Lowers volume**
- ❿ **Raises volume**
- ⓫ **Repeat** : Repeat mode
- ⓬ **Source** : N/A

### REPLACING USB REMOTE BATTERY

- Locate the battery compartment on the bottom of the remote control.
- Press and hold tenon and then slide out the battery tray.
- Remove the old battery and insert the new battery in, making sure that the battery's positive (+) side is facing up.
- Slide the battery tray back into the remote control until it clicks.

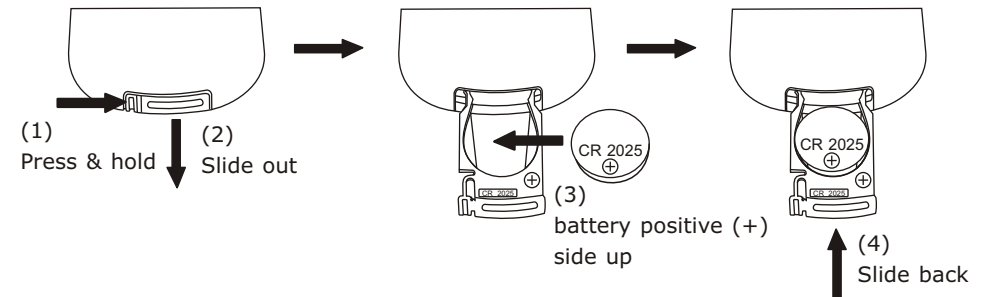

#### Notes:



- MA-100 uses a CR2032 lithium 3.0V coin battery that is commonly used in small electronic devices. You'll find these batteries at most electronics and drug stores.
- Remote control operates on an infrared (IR)-based technology. If it has an unobstructed line-of-sight, the remote control can function at distances of up to 5 meters (about 17 feet).
- Dispose of the used battery according to local environmental laws and guidelines.



## REPLACING THE RECHARGEABLE BATTERY

With a proper care and charging, it is unlikely that the rechargeable battery needs to be replaced by a new battery for some time. You may consider to have a backup battery in case you need to use MA-303 for a longer time. The rechargeable lithium battery is available from MIPRO.

## INSTRUCTION OF CHARGING THE RECHARGEABLE BATTERY

- Charge the battery completely in its first use to obtain its maximum capacity.
- Connect to any available AC power outlet using the included DC adapter to the DC IN  jack .
- The battery meter  LED blinks while charging. Blinking LED may start later if the battery suffers from excessive battery drain. The battery may be damaged if the LED does not blink after charging for a while.
  - The battery is low when only the red LED is on. Please recharge the batter for at least 4 hours (the time of charging depends on the type of battery).
  - All LED blinking means the battery is charging.
  - Charging completes when all LED are on.
- Fully charge the battery after each use or minimum once every 3 months.
- Improper maintenance or over discharge the battery will not be covered by the warranty.
- The battery stops charging when it is fully charged. It is safe to leave it connected to the power overnight.

### Note:

- The rechargeable battery pack is user replaceable. Rechargeable batteries have a limited number of charge cycles and may eventually need to be replaced. Battery life and number of charge cycles vary by use and settings.

## Steps of Changing the Rechargeable Battery

- Lay the PA system on a flat surface. Power off and gently remove USB from USB port, if needed.
- Remove the two screws so the battery cover can be opened and removed.
- The battery pack is stored inside the compartment slot. Pull out the battery gently and remove it completely by detaching the connecting pins.
- Insert the replacement battery pack. Ascertain the connecting pins are connected firmly before inserting. Carefully slide the battery back into the compartment slot.
- Insert back the two screws back in place securely.

### Warning:

- Never short-circuit the battery pack by either accidentally or intentionally bringing the battery terminals in contact with another conductive object. Never expose a battery pack to abnormal shock, vibration or pressure. Failure to observe the foregoing could result in serious injury.

### Note:

- Dispose of the used battery according to local environmental laws and guidelines.

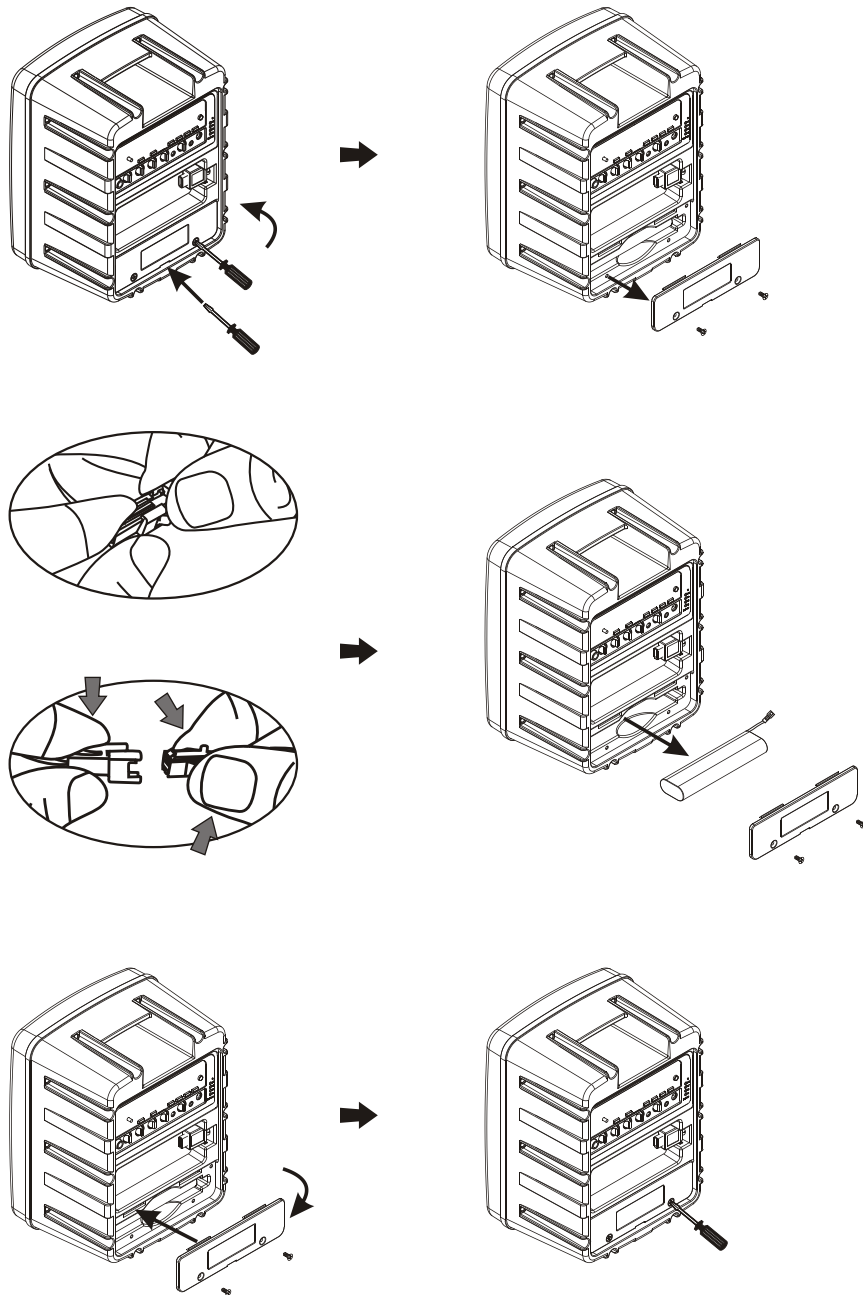

## SYSTEM CHANNEL SET-UP

### Wireless Mic System

- Turn on master **Power/MIC VOL** switch ❸. **Power** indicator ❶ glows red. Ready for operation.
- Turn on **CH 1 VOL** ❷ or **CH 2 VOL** ❹ VOL switch.
- Turn transmitter power on. Ensure fresh *alkaline or lithium* batteries (not included) are installed.
- **RF** indicator ❺ or ❻ glows green after the transmitter is turned on to denote a successful RF link.
- Adjust **CH 1 VOL** ❷ or **CH 2 VOL** ❹ to desired volume.
- Ensure receiver and transmitter have the same matching operating channels. (see page 17: Corresponding Channel Display: MA-303 Receiver and Transmitter) If not, perform ACT Synchronization (Sync) between Receiver and Transmitter Channels (see page 18 ).

### Notes:

- Same wireless microphone can transmit to multiple MA-303 systems on the same channel for a wider and expanded coverage.
- It is not possible to transmit two wireless microphones on the same channel to MA-303 system. Only one transmitter can be used at a time on that channel. Be sure to turn off one of the two transmitters to avoid interference.

### Scanning Receiver Channels

- There are 16 channels available. The receiver will scan through the channels in the following order and shown on the LED screen:

1 → 2 → 3 → 4 → 5 → 6 → 7 → 8 → 9 → 0 → A → B → C → D → E → F → 1 → 2 → ...

### To Scan for a Clear Receiver Channel

- Press & release the **SCAN/ACT** button until current channel blinks.
- During blinking, press & release the **SCAN/ACT** button a second time.
- The receiver scans and sets at a clear channel automatically.

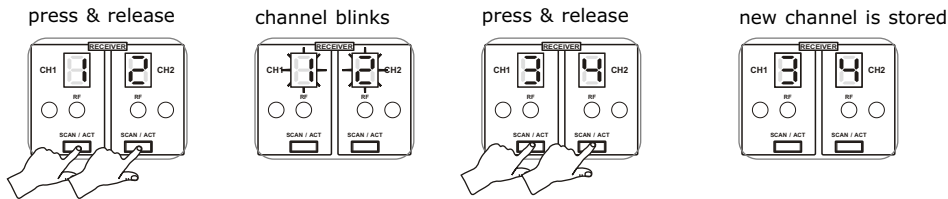

### Manually Forcing a Channel Change

- Press & hold the **SCAN/ACT** button until current channel blinks.
- Release the **SCAN/ACT** button until a desired channel is reached.
- This will force the receiver to change to the next available clear channel.

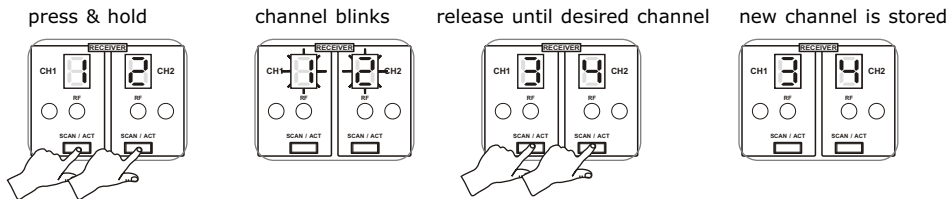

### When to Change Channel

- Interference occurs during performance.
- When two or more MA-303s need to be used at the same venue.
- Do not select a new channel while another system is operating as it may interfere.
- If “\_” is displayed during channel scanning this indicates the current channel in this frequency band is experiencing interference. If problem persists, it is recommended to change and use a different frequency band.

### Corresponding Channel Display: MA-303 Receiver and Transmitter

<b>MA-303</b>	<b>1</b>	<b>2</b>	<b>3</b>	<b>4</b>	<b>5</b>	<b>6</b>	<b>7</b>	<b>8</b>
Transmitter LCD	01 01	01 02	01 03	01 04	01 05	01 06	01 07	01 08
<b>MA-303</b>	<b>9</b>	<b>0</b>	<b>A</b>	<b>B</b>	<b>C</b>	<b>D</b>	<b>E</b>	<b>F</b>
Transmitter LCD	01 09	01 10	01 11	01 12	01 13	01 14	01 15	01 16

### ACT Synchronization (Sync) between Receiver and Transmitter Channels:

- Power on handheld or bodypack transmitter. Ensure fresh batteries are properly installed with correct polarity.
- Locate and bring the transmitter sync port (red indicator) within 30cm (12-inch) of **CH 1** or **CH 2** receiver sync port **18** or **21**.
- Press and release **SCAN/ACT** button to synchronize receiver and transmitter channels (See diagram 1)
- During syncing, the channel indicator in **CH 1** **15** or **CH 2** **12** will blink and LCD on the transmitter will display corresponding four digital numbers (see Corresponding Channel Display: MA-303 Receiver and Transmitter on page 17)
- When the channels are synchronized the channel indicator in channel screen stops blinking and **RF** indicator **14** or **16** glows green to indicate a successful RF link.
- The transmitter is now set to the new channel and ready for operation.
- Repeat steps if channel indicator remains flashing and no glowing green RF indicator.

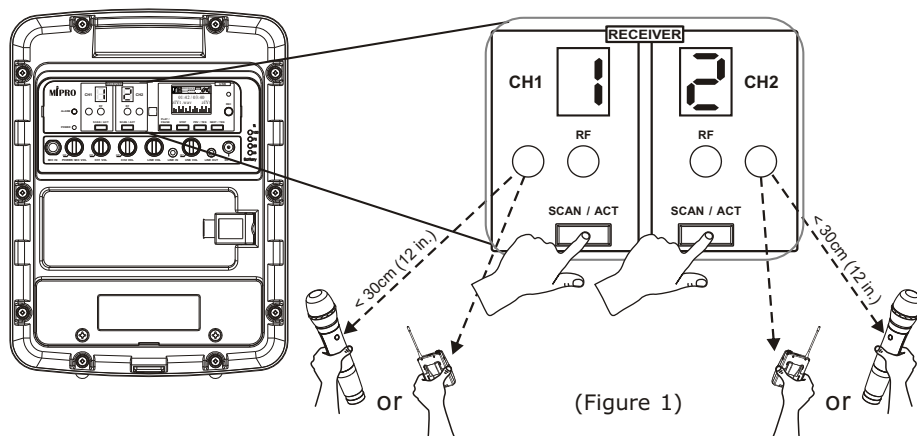

### OPERATING INSTRUCTIONS

#### Wired Microphone

- Plug optional MIPRO MM-107 wired dynamic microphone with a 6.3mm (1/4") connector to **MIC IN** **30**.
- Turn on master **POWER / MIC VOL** **31** and adjust to desired volume.

#### Line Input

- Available to connect an external CD, MP3, iPod or cassette player.
- Connect a 3.5mm-to-3.5mm audio cable (not included) to the **LINE-IN** **35** jack .
- Turn on master **POWER / MIC VOL** **31**.
- Adjust **LINE VOL** **34** to desired volume.

#### Play USB Drive

- Insert USB drive into USB 2.0 port.
- Turn master **POWER/MIC VOL** **31** power on.
- Turn **USB VOL** **36** power on. Display screen will light when USB player is turned on.
- Press & release **NEXT / TEN** button **26** for next track. Press & hold **NEXT / TEN** button **26** skips forward next 10 tracks.
- Press & release **PRV / TEN** button **27** for previous track. Press & hold **PRV / TEN** button **27** skips backward previous 10 tracks.

#### Record USB Drive

- Insert USB drive into USB 2.0 port.
- Turn master **POWER/MIC VOL** **31** power on.
- Turn **USB VOL** **36** power on. Display screen will light when **USB** player is turned on.
- Press & release **STOP** button **28** for WAV recording format.
- Press & release **REC** button **25** for recording mode. Press the button second time starts recording. **REC** button glows during recording.
- Press **STOP** button **28** to stop recording.
- Press **PLAY/PAUSE** button **29** for playback recording.

### Repeat Play

- Press **PRV / TEN** button **27** or **NEXT / TEN** button **26** to repeat.
- Normal → Repeat one → Folder → Repeat Folder → Repeat All → Random Intro

### Alarm Siren

- Press **Alarm** button **15** for warnings of approaching or presence of threats or situations requiring immediate attention.
- Alarm will sound only when master **Power / Mic Volume** **27** is powered on and one of below function is powered on.
  - wireless transmitter and CH 1 or CH 2 are powered on.
  - wired microphone is plugged into the Mic input and powered on.
  - USB player is powered on & music is playing.

### USB DRIVE OPERATION

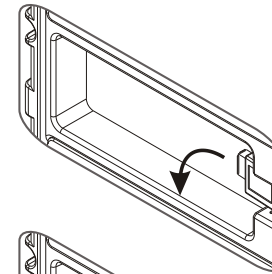

Standard USB port storage position  
Pull out the USB port to a 90 degree angle

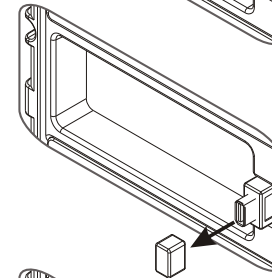

Remove the protective cap

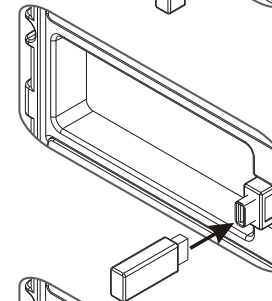

Insert a Type-A USB disk (USB 2.0 interface)

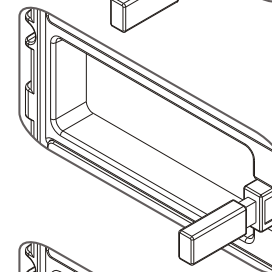

Ensure USB disk is plugged firmly and securely.

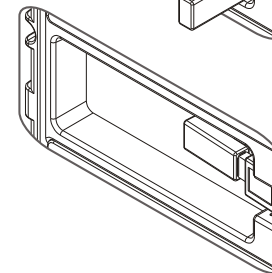

Push back the USB port into the standard position to prevent accidental issues.

**CONNECTION TO EXTERNAL AUDIO SOURCES**

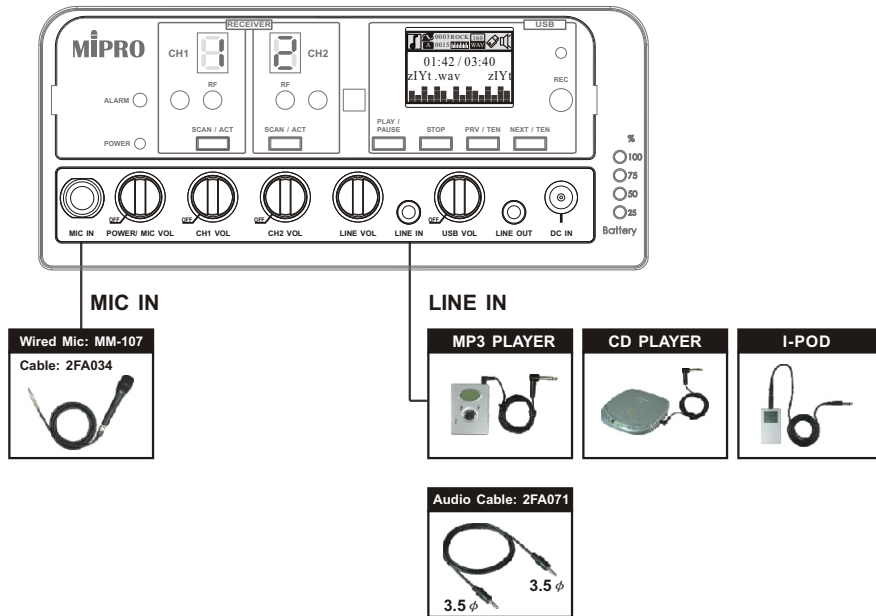

**FOUR AVAILABLE CONFIGURATIONS**

**MA-303s Personal Wireless PA System**

Single-Channel. No USB Player & Recorder

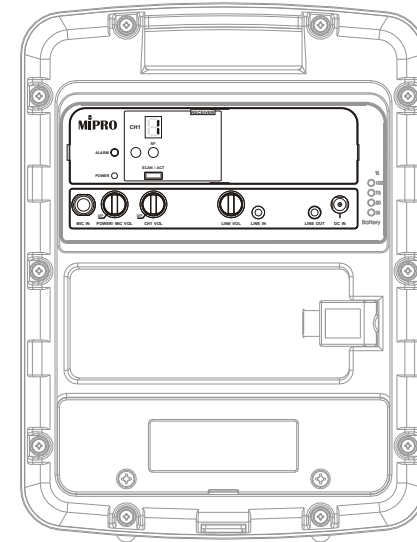

**MA-303d Personal Wireless PA System**

Dual-Channel. No USB Player & Recorder

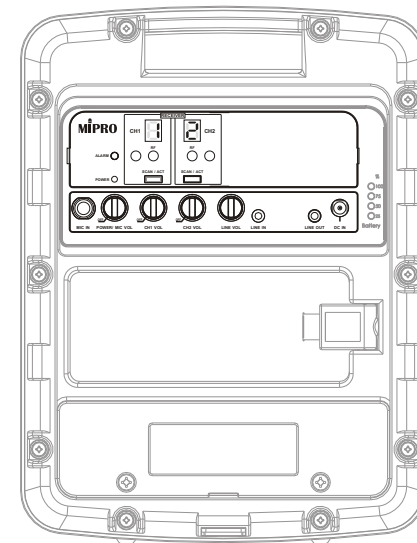

**MA-303su Personal Wireless PA System**

Single-Channel +USB Player & Recorder

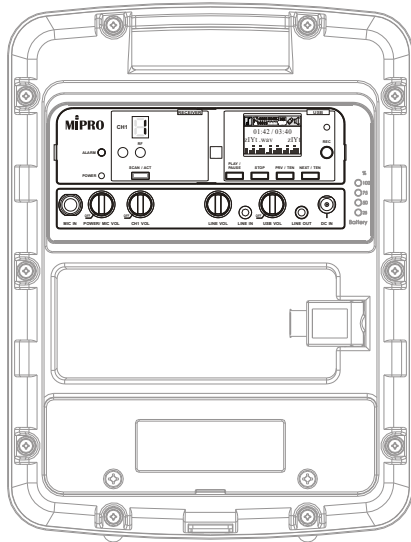

**MA-303du Personal Wireless PA System**

Dual-Channel +USB Player & Recorder

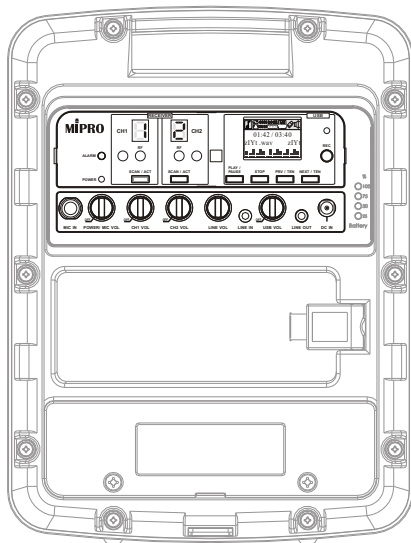

**TROUBLESHOOTING-PORTABLE PUBLIC ADDRESS**

PROBLEM	POSSIBLE CAUSE	SOLUTION
No Sound or Faint Sound From Speaker	Volume turned down	Adjust volume
	Power switch is turned off	Turn power switch on
Power Indicator Not On	Power switch is turned off	Turn power switch on
	Rechargeable Battery is discharged	Plug into AC outlet to recharge
	Rechargeable Battery is "dead"	Replace battery and plug into AC outlet to recharge
Distorted Sound From Speaker	Volume set too high	Reduce volume
	Excessive wind noise or breath "pops"	Use windscreen on wireless & wired microphones.
	Input signal too strong	Adjust input signals
Excessive Feedback	Microphone too close or directly in front of the speaker	Move microphone away from the speaker
	Volume set too high	Reduce volume
	Microphone too far from sound source (requiring the volume to be turned up to compensate)	Speak closer to the microphone or move microphone closer to sound source
Weak, Distorted Sound. Power Indicator Flickers	Batteries level is low	Plug into AC outlet to recharge
Excessive Hum or Noise	Input Cable not shielded	Use shielded cable
Shortened Battery Life	Old or overused battery	Recharge or replace battery
	Battery is not charged for over 3~4 months	Recharge or replace battery
Battery CHARGE Indicator Not Flickering when plugged into AC Outlet	Rechargeable Battery is "dead"	Replace battery
	Battery is not charged for over 3~4 months	Recharge or replace battery
	Battery is fully charged (CHARGE indicator is lit)	N/A

**TROUBLESHOOTING-WIRELESS MICROPHONE SYSTEMS**

PROBLEM	POSSIBLE CAUSE	SOLUTION
No Sound From Speaker	Master or receiver volume turned down	Adjust volumes
	Transmitter or receiver switch is turned off	Turn transmitter or receiver switch on
	Receiver and transmitter have different frequencies	See "Set-up Receiver & Transmitter Frequencies" section
	Transmitter battery is low or no battery inside	Replace or insert new battery
	Headset or lavalier microphone is not plugged into bodypack transmitter	Plug headset or lavalier microphone into bodypack transmitter
Distortion or Unwanted Noise Bursts	Interference	Remove nearby sources of RF interference (computers, amplifiers, karaoke machines, digital effects, CD players, etc)
	Noise Indicator is lit	Adjust "Sensitivity" on receiver.
		If problem persists, change Receiver & Transmitter frequencies.
		See "Set-up Receiver & Transmitter Frequencies" section
Sound Dropouts	Out of operating range	Move transmitter closer to receiver
	Obstructions between the receiver and transmitter	Remove obstructions or reposition
		Line-of-sight between receiver & transmitter
	Weak Transmitter Battery	Replace Transmitter Battery
	Interference	Change Receiver & Transmitter frequencies
See "Set-up Receiver & Transmitter Frequencies" section		

**FAQ - PORTABLE PA**

**Q: How to adjust for optimal sound volume?**

A: If the portable system has both Master & Microphone volumes, we recommend turning the Master volume to about 3pm (clockwise) first and about 1~2pm (clockwise) for Microphone or other volumes.

**Q: How to prevent and minimize the annoying feedback?**

- A1: Do not stand directly in front of the speakers; keep mics away from speakers.
- A2: Avoid pointing microphone towards the speakers.
- A3: The microphones should be behind the speakers wherever possible.
- A4: Locate the portable PA between the crowd and the presenters and facing the crowd.
- A5: Turn down the sound level coming out of the portable PA / speakers if necessary.
- A6: Place the speakers above the head of the crowd.

**Q: What if I need more power to cover a larger crowd?**

A: Two or more portables can be used with one wireless microphone transmitter. Ascertain that the receiver frequency in each portable coincides with the wireless microphone.

**Q: Can I play music through the systems?**

A: Yes. All MIPRO portables have auxiliary inputs (3.5mm min-jack, RCA or 1/4"phone), which will accept input from an external iPod, MP3, CD, cassette, VCR, DVD players. As well, modular CD players can be inserted into most models.



## FAQ - RECHARGEABLE BATTERY

**Q: How to Charge the Battery?**

A: Simply plug into a power outlet using the included power cable and adapter. "Flashing" LED indicates it is charging. The main power switch can be on or off position during charging. Microphones or music can be used during charging & power is on.

**Q: How to Spot System Low Battery?**

A: When Power LED is lit (MA-705 & MA-707) or Charge LED is lit (MA-101& MA-101a) or one indicator remaining in battery meter (MA-100, MA-202, MA-303, MA-708, MA-808). Plug into a power outlet to re-charge ASAP.

**Q: Average Life Span of Rechargeable Lithium or Sealed Lead-Acid Battery?**

A: The batteries should have a life of up to 2 years if used and maintained properly. Battery life is determined by temperature, depth and rate of discharge, and the number of charges and discharges (called cycles).

**Q: When to Replace the Battery?**

A1: Power LED indicator is not "lit" when power on. (No battery voltage).

A2: LED indicator or meter is not "flashing" when plugged-in.

A3: Getting 1~2 hours operating time per charge.

A4: When battery has been used extensively for 2 years or more.

## RECHARGEABLE BATTERY GUIDE

**Tips - To Prolong the Life of Rechargeable Batteries**

- ☑ Power off the portable system and transmitter/mic when NOT in use.
- ☑ Store portable system with batteries in a fully charged condition.
- ☑ Most lithium-ion polymer batteries use a fast charge to charge your device to 80% battery capacity, then switch to trickle charging. That's about two hours of charge time to power up to 80% capacity, then another two hours to fully charge it, if you are not using the portable PA system while charging.
- ☑ The battery prefers a partial rather than a full discharge. A partial discharge reduces stress and prolongs battery life.
- ☑ Avoid frequent full discharges because this puts additional strain on the battery. Several partial discharges with frequent recharges are better for lithium-ion than one deep one.
- ☑ Avoid keeping the battery at full charge and high temperature.  
It is OK to leave the system plugged into a power outlet when not being used for a long time. The built-in automatic protection circuitry will auto shut-off when fully charged. It will not harm the system or the battery.
- ☑ Fully charge the system at least once every 3~6 months. Battery may not charge if not charged for a prolonged periods of time.
- ☑ Do not freeze the battery. Store in dry, cool place away from heat. Elevated temperature reduces battery lifespan.
- ☑ Rechargeable batteries have a limited number of charge cycles and may eventually need to be replaced. Battery life and number of charge cycles vary by use and settings.

CAUTION: DO NOT recharge other types of batteries and connect a battery's negative terminal to another batteries positive terminal. An explosion and/or a fire could occur as a result. Use only authorized rechargeable lithium batteries.

**OPTIONAL MA-303 ACCESSORIES**

**MB-10: 14.8V/2.6AH Rechargeable Lithium Battery**

MA-303 requires 1 MB-10 batteries

**MS-30: Microphone Tripod Stand**

Adjustable stand for MA-303 portable PA system

**SC-30: Carrying Case**

Carrying case and storage. Storage for wireless & wired microphones cable, battery

**MM-107: Handheld Wired Microphone**

MIPRO's Hypercardioid Dynamic Microphone with cable.

**ASP-10: Aerobic Sports Pouch**

Sweat-resistant transmitter pouch belts for MIPRO bodypack transmitters.

**MIPRO WIRELESS MICROPHONE SYSTEMS FOR MA-303**

**ACT-30H - Handheld Transmitter Microphone (2 AA : not included)**

**ACT-30T - Body Pack Transmitter (2 AA : not included)**

(microphone not included - see below)

**MU-53HN (black) ; MU-53HNS (beige) - Premium Headworn Microphone**

Uni-directional, Premium 10mm, Ideal for speech and singing. Works with all MIPRO bodypack transmitters

**MU-55HN (black) ; MU-55HNS (beige) - Subminiature Headworn Microphone**

Omni-directional, 4.5mm, Sweat-proof, Ideal for speech. Works with all MIPRO bodypack transmitters

**MU-13 (beige) - Premium Single-sided Earworn Microphone**

Omni-directional, ultra small & lightweight 3mm, Ideal for speech. Works with all MIPRO bodypack transmitters

**MU-23 (beige) - Premium Dual-sided Headworn Microphone**

Omni-directional, ultra small & lightweight 3mm, Ideal for speech. Works with all MIPRO bodypack transmitters

**MU-53L (black) ; MU-53LS (beige) - Premium Lavalier Microphone**

Uni-directional, 10mm, High-gain-before-feedback, warm, clear sound. Works with all MIPRO bodypack transmitters

**MU-55L (black) ; MU-55LS (beige) - Subminiature Lavalier Microphone**

Omni-directional, 4.5mm, Low visibility, Works with all MIPRO bodypack transmitters

**TECHNICAL SPECIFICATIONS**

Model	MA-303s	MA-303d	MA-303su	MA-303du
<b>Portable PA</b>				
Power Output	55W RMS / 60W Max			
Amplifier	Class D			
T.H.D.	<1%			
Frequency Response	50Hz~18KHz			
Loudspeaker	1 " Tweeter & 5 " Woofer			
Audio Input	Wired	6.3mm (1/4")		
	Line-Input	3.5mm (1/8")		
Audio Output	3.5mm (1/8")			
Installation	Microphone stand, table mounted, handle			
Power Supply	AC	External 100-240V AC switching power supply		
	DC & Battery	14.8V/2.6AH rechargeable lithium battery		
Charge Time	Up to 4 hours (automatic charging management)			
Stand-by Time	Up to 12 hours	Up to 11 hours	Up to 10 hours	Up to 9 hours
Charge Indicator	4-level Battery Meter			
Color	Black			
Dimensions	210(W)x 276(H)x 165(D) mm			
	8.3 (W)x 11(H)x 6.5(D) inches			
Weight (battery included)	Approx. 2.7 kg	Approx. 2.8 kg	Approx. 2.7 kg	Approx. 2.8 kg
	(6 lbs)	(6.2 lbs)	(6 lbs)	(6.2 lbs)
<b>Wireless System</b>				
Receiver Channel	Single	Dual	Single	Dual
Frequency Range	UHF 620 ~ 934 MHz			
Frequency Band	24 MHz			
Preset Channel	16			
Channel Set-up	Scan & ACT sync			
Transmitter	ACT-30H Handheld / ACT-30T Bodypack			
Antenna	Built-in			

Personal Wireless Public Address System

Model	MA-303s	MA-303d	MA-303su	MA-303du
<b>Audio Player</b>				
Built-in 2.0 USB Port	N/A		Yes	
Play & Record	N/A		Yes	
Patents & Approvals	Patented. Telecom and safety regulations approved			
Notes	<ul style="list-style-type: none"> <li>• Refer to actual product in the event of product discrepancy</li> <li>• Frequency range and maximum deviation comply with regulations of different</li> </ul>			

Personal Wireless Public Address System